

# Carbon dioxide Sensor Module IAGCO2

Specification Sheet Rev.0.2

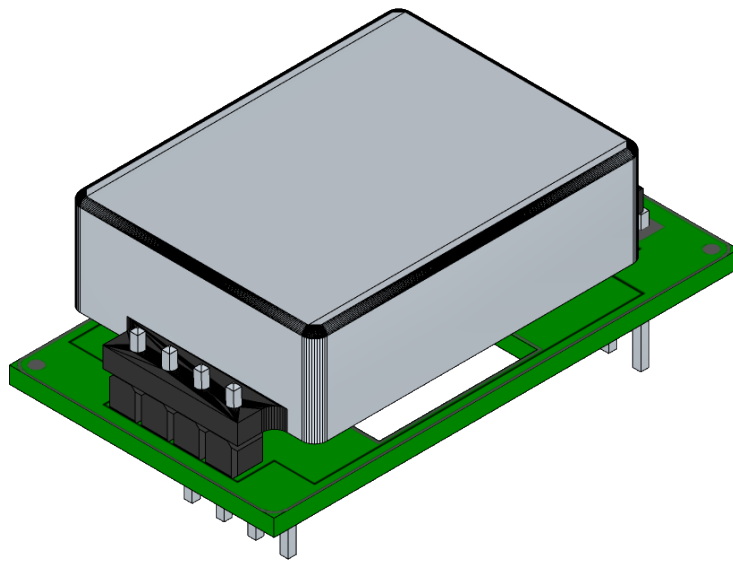

IAGCO2 is a digital carbon dioxide gas sensor. Idea for indoor air quality monitoring, security monitoring or wireless sensor networks to detect carbon dioxide concentration near the installation location. This sensor is a proven and maintenance-free technology, designed for high performance and reliability.

## Key Feature & Benefits:

- Fast response and recovery time:
- High stability & long life:
- Low cost but high performance:
- Wide operating ranges:
  - ◆ temperature: -10 to +50°C
  - ◆ humidity: 15 to 90%
  - ◆  $V_{DD}$ : 4.8V to 5.2V
  - ◆  $V_{DDIO}$ : 3.1V to 3.5V
- Hassle-free:
  - on-chip data processing – no need for external libraries – no impact on MCU

## Applications:

- Building Automation / smart home / HVAC
  - ◆ Demand-controlled ventilation
  - ◆ Smart thermostats
- Home appliances
  - ◆ Air cleaners
  - ◆ Purifiers
- Air quality monitors
- IoT devices

## Block diagram:

The IAGCO2 digital carbon dioxide gas sensor based on Non-dispersive infrared (NDIR) technology, and a controller as shown in the functional block diagram below.

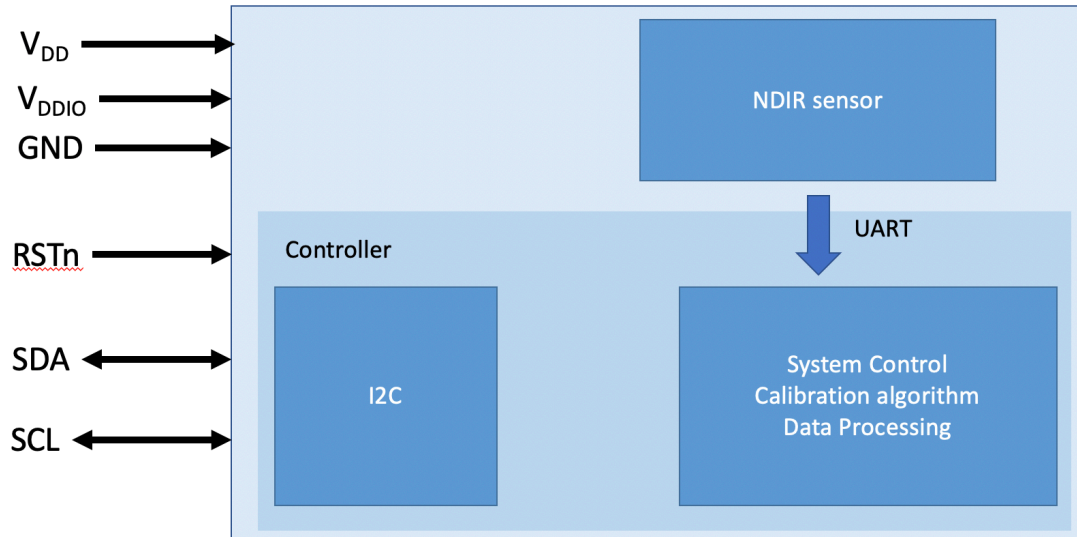

## Specification:

The following figure details the electrical characteristics of the sensor.

Model	IAGCO2	
Detection	Carbon dioxide (CO <sub>2</sub> )	
Principle	Non-dispersive infrared (NDIR)	
Measurement range	0 to 5000	ppm
Resolution	1	ppm
Accuracy	$\pm 50 \pm 3\%$ of reading	ppm
Response time(T90)	<120	sec
Operation temp.	-10 to 50	°C
Operation Humidity	15 to 90	%RH
Expected operating life	3	years
Power supply	$V_{DD}$ : 4.8 to 5.2 $V_{DDIO}$ : 3.1 to 3.5	V
Power consumption	150	mW
Interface	I <sup>2</sup> C	
Dimension(mm)	37(L) 21(W) 14(H)	mm

# Dimensions:

Side view

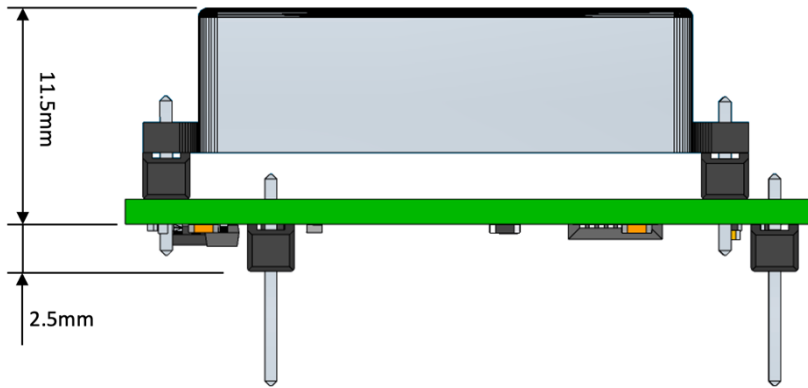

Top view

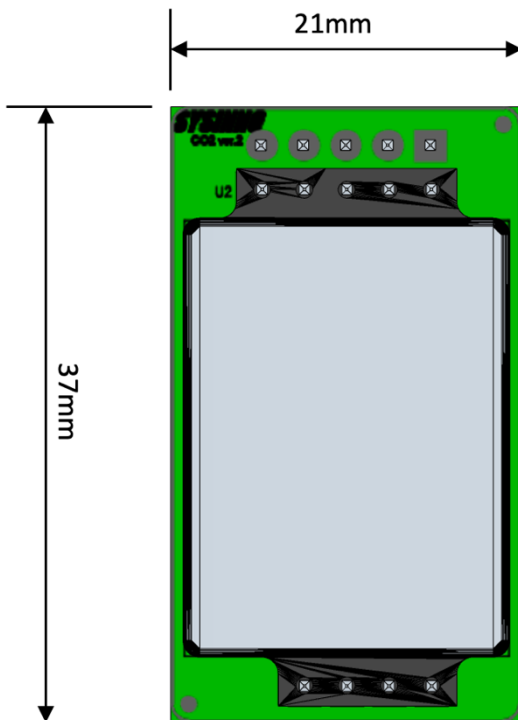

Bottom view

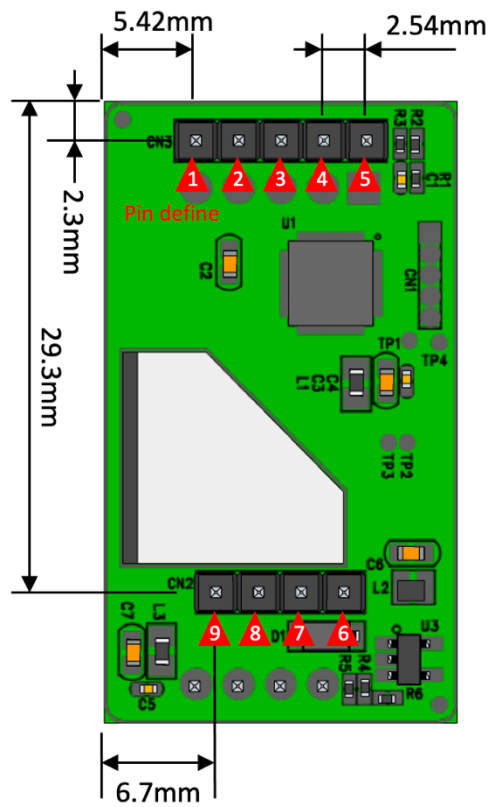

## Pin assignment:

Pins	Name	Type	Function
1	V <sub>DDIO</sub>	Supply	Interface power supply (3.3V)
2	SDA	Input / Output	I2C bus Bi-Directional data
3	SCL	Input / Output	I2C bus Bi-Directional clock
4	GND	Supply	Ground
5	RSTn	Input	Reset pin(Low Voltage reset)
6	GND	Supply	Ground
7	NC	Input / Output	Reserved
8	NC	Input / Output	Reserved
9	V <sub>DD</sub>	Supply	Main power supply (5V)

# I2C Communication:

## I2C description:

This sensor is an I2C slave device with a fixed 7-bit address **5Fh**. The I2C interface supports standard (100kbit/s), and fast (400kbit/s) mode. Details on I2C protocol is according to I2C-bus specifications [UM10204, I2C-bus specification and user manual, Rev. 6, 4 April 2014].

The device applies all mandatory I2C protocol features for slaves: START, STOP, Acknowledge and 7-bit slave address. None of the other optional features (10-bit slave address, general call, software reset or Device ID) are supported, nor are the master features (Synchronization, Arbitration, START byte).

The Host System, as an I2C master, can directly read or write values to one of the registers by first sending the single byte register address. This sensor implements “auto increment” which means that it is possible to read or write multiple bytes\* (e.g. read multiple DATA\_X bytes) in a single transaction.

**\*NB: Please do not read or write more than 16 bytes.**

## I2C timing information:

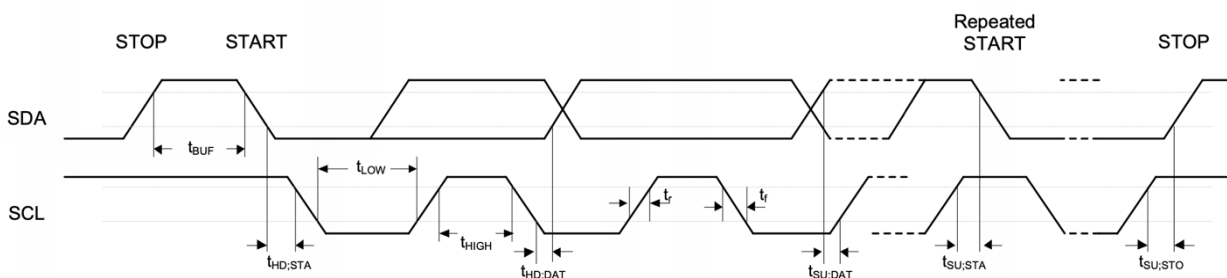

SYMBOL	PARAMETER	STANDARD MODE <sup>[1][2]</sup>		FAST MODE <sup>[1][2]</sup>		UNIT
		MIN.	MAX.	MIN.	MAX.	
$t_{LOW}$	SCL low period					$\mu s$
$t_{HIGH}$	SCL high period					$\mu s$
$t_{SU,STA}$	Repeated START condition setup time					$\mu s$
$t_{HD,STA}$	START condition hold time	4	-	0.6	-	$\mu s$
$t_{SU,STO}$	STOP condition setup time	4	-	0.6	-	$\mu s$
$t_{BUF}$	Bus free time	4.7 <sup>[3]</sup>	-	1.2 <sup>[3]</sup>	-	$\mu s$
$t_{SU,DAT}$	Data setup time	250	-	100	-	ns
$t_{HD,DAT}$	Data hold time	0 <sup>[4]</sup>	3.45 <sup>[5]</sup>	0 <sup>[4]</sup>	0.8 <sup>[5]</sup>	$\mu s$
$t_r$	SCL/SDA rise time	-	1000	20+0.1Cb	300	ns
$t_f$	SCL/SDA fall time	-	300	-	300	ns
$C_b$	Capacitive load for each bus line	-	400	-	400	pF

1. Guaranteed by design, not tested in production.
2. I2C controller must be retriggered immediately at slave mode after receiving STOP condition.
3. The device must internally provide a hold time of at least 300 ns for the SDA signal in order to bridge the undefined region of the falling edge of SCL.
4. The maximum hold time of the Start condition has only to be met if the interface does not stretch the low period of SCL signal.

■ I2C operation circuitry:

The recommended application circuit for the sensor I2C interface operation is shown in below.

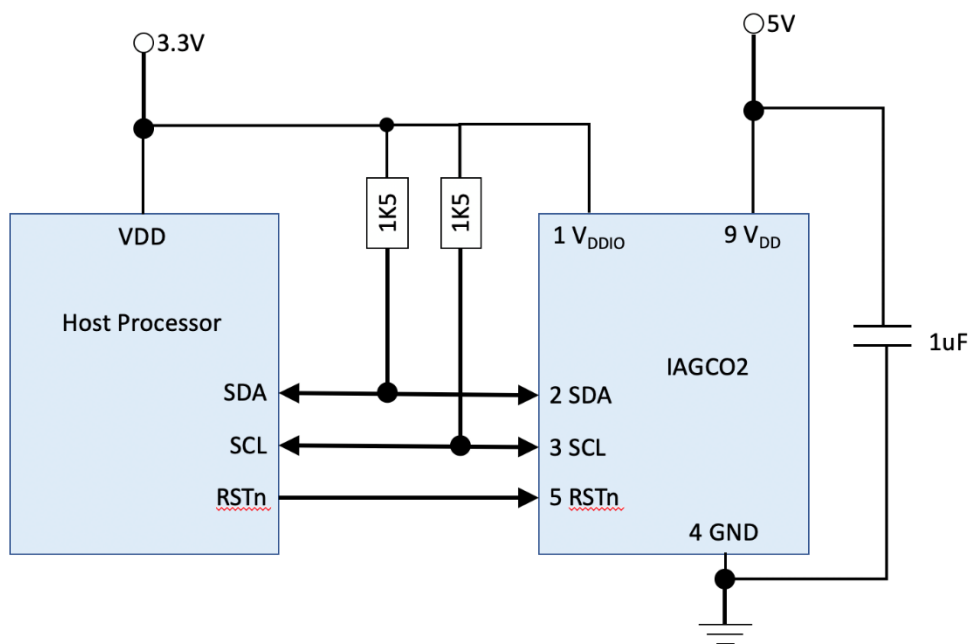

■ I2C Access Protocol:

I2C write operation:

TBD

I2C read operation:

Write register address first, then read data.

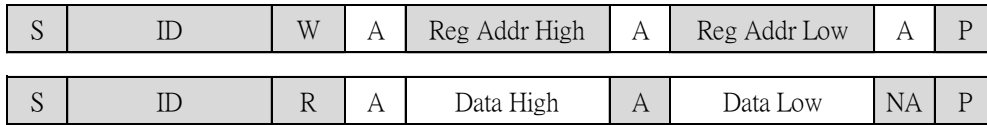

Master to Slave  
 Slave to Master

ID = 5Fh (CO Module 7-bits I2C address)

S = START condition

P = STOP condition

A = acknowledge (SDA LOW)

NA = not acknowledge (SDA HIGH)

W = WRITE (SDA LOW)

R = READ (SDA HIGH)

I2C register:

Address	Data	Size	Access	Description
0000h	PID	8	Read	Product ID Return device product code. (ASCII Code format.) e.g. IAGCO2
0008h	FW	8	Read	Firmware version Return device firmware version. (ASCII Code format.)
0010h	SNO	16	Read	Serial Number Return device serial Number. (ASCII Code format.)
0020h	Status	1	Read	Module status 0: Normal operation 1: Warm-Up pse 2: Error case
0021h	CO2	2	Read	Carbon dioxide (CO <sub>2</sub> ) gas concentration unit: 1 ppm e.g. 1000 = 1000 ppm



## ■ Example Code:

```
#define SlaveDeviceID      0x5F
#define ProductID_RegAddr  0x00
#define FWVersion_RegAddr  0x08
#define SNO_RegAddr        0x10
#define CO2Data_RegAddr    0x21
#define CO2Data_Length     2
#define INI_CO2_PPM        380
#define UL_CO2_PPM         5000
#define LL_CO2_PPM         0
#define IIROrder           4
#define CO2_Slope          1 //Declare it as a variable for runtime calibration.
#define CO2_Offset         0 //Declare it as a variable for runtime calibration.
#define BYTE0(arg)         (*((Uchar *)&(arg) + 0))
#define BYTE1(arg)         (*((Uchar *)&(arg) + 1))
//=====
// Function      :I2C_ReadData
// Format         :void I2C_ReadData(uint8_t DeviceID, uint16_t RegAddr, uint8_t *i2cbuf, uint8_t Length)
// Explain       :Read device data via i2c
// Parameter     :DeviceID : I2C slave device address
//               :RegAddr  : Data register address
//               :i2cbuf   : Store the data read from the device.
//               :Length   : Indicate the number of reading bytes.
// Return        :Error code: 0: success, !=0: fail
//=====
extern uint32_t I2C_ReadData(uint8_t DeviceID, uint16_t RegAddr, uint8_t *i2cbuf, uint8_t Length);
int16_t      ErrorCount = 0;
int32_t      CO2IIR = INI_CO2_PPM;
int32_t      iTmpCO2, CO2Data;
uint8_t      I2CBuffer[16]; //for I2C buffer
int main(void)
{
    //Do system initialization based on your host MCU.
    system_init();
    //Below is an example showing how to read CO2 module data once per second.
    while(1)
    {
        if(I2C_ReadData(SlaveDeviceID, CO2Data_RegAddr, I2CBuffer, CO2Data_Length) != 0) //Read CO2 module data
        {
            //Read CO2 data fail! Do some error process, below is an example.
            ErrorCount++;
        }
        else
        {
            ErrorCount = 0;
            BYTE1(iTmpCO2)=I2CBuffer[0];
            BYTE0(iTmpCO2)=I2CBuffer[1];
        }
        //Add some data filters here, below is an example.
        if (CO2IIR <= INI_CO2_PPM)
            CO2IIR = iTmpCO2;
        else
            CO2IIR = ((CO2IIR * (IIROrder-1)) + iTmpCO2) / IIROrder;//IIR filter (3/4 Old + 1/4 New)

        CO2Data = CO2IIR * CO2_Slope + CO2_Offset; //Calibration mechanisms

        if (CO2Data > UL_CO2_PPM) CO2Data = UL_CO2_PPM; //Clamp upper limit
        if (CO2Data < LL_CO2_PPM) CO2Data = LL_CO2_PPM; //Clamp lower limit

        if (ErrorCount)
            printf("Read CO2 Data Fail! CO2:%d ppm\n", CO2Data);
        else
            printf("Read CO2 Data OK! CO2:%d ppm\n", CO2Data);
        HAL_Delay(1000); //delay 1000ms
    }
}
```