



## PET-7H16M

Ethernet High Speed Data Acquisition Module with  
8-ch AI, 4-ch DI, 4-ch DO and PoE

### Features

- 8 Single-ended Analog Input Channels (16-bit Resolution)
- Supports Real Sample and Hold
- 16-bit ADC with built-in anti-aliasing filter
- Max. Sample Rate: 200 kS/s
- Built-in I/O
  - AI: 8 Channels
  - DI: 4 Channels
  - DO: 4 Channels
  - 4-Ch Low-speed and 1-Ch High speed Counters



### Introduction

The PET-7H16M is a high speed data acquisition devices with a built-in Ethernet communication port for data transfer over a network, and includes 8 high-speed 16-bit single-ended Analog input channels (200 kHz sample and hold for all 8 channels), 4 Digital Input channels and 4 Digital Output channels. The module provides a programmable input range on all analog channels ( $\pm 5$  V and  $\pm 10$  V), and the Digital Output can be set to output with short-circuit and overload protection. The counter value of 4-channel Low-speed DI counters and 1-channel High-speed counter are latched by ADC sampling time synchronously. The PET-7H16M also provides 4 kV ESD protection as well as 2500 VDC intra-module isolation.

#### \* External Digital Signal Event includes Pre/Post/Delay-trigger

Acquisition	Trigger	Software AD	External CLK AD	External Digital Signal Event	Analog Threshold
Continuous Mode		1 ~ 30 kHz	1 ~ 30 kHz	-	-
N Sample Mode		30 kHz ~ 200 kHz 125 secs (30 kHz), 19.6 secs (200 kHz)	-	1 ~ 200 kHz	1 ~ 200 kHz

### System Specifications

Software	
OS	Windows 7/8/10 and Linux
Utility	Configuration, graphically display and data logging
SDK	Windows <ul style="list-style-type: none"> <li>• Microsoft VC, C#, VB.NET SDK API and Demo</li> <li>• Python Demo</li> <li>• NI LabVIEW Toolkit and Demo</li> </ul> Linux <ul style="list-style-type: none"> <li>• C/C++ library and Demo</li> <li>• .NET library and Demo</li> <li>• Python Demo</li> </ul>
Communication	
Ethernet Port	1 x RJ-45, 10/100 Base-TX
PoE	Yes, IEEE 802.3af, class 2
Security	ID, Password and IP Filter
Protocol	TCP Steaming (Access data by SDK library) Modbus TCP
LED Indicators	
Status	1 x System, 1 x Ethernet, 1 x PoE

EMS Protection	
ESD (IEC 61000-4-2)	4 kV Contact for each terminal and 8 kV Air for random Point
ESD (IEC 61000-4-4)	+/- 4 kV for power
2-way Isolation	
I/O	2500 VDC
Power	
Reverse Polarity Protection	Yes
Powered from Terminal Block	+12 ~ +48 VDC
Consumption	2.6 W
Mechanical	
Dimensions (W x L x H)	76 mm x 120 mm x 38 mm
Installation	DIN-Rail, Wall Mounting
Casing	Metal
Environmental	
Operating Temperature	-25 °C ~ +75 °C
Storage Temperature	-30 °C ~ +80 °C
Humidity	10 ~ 90 % RH, Non-condensing

## I/O Specifications

Analog Input	
Channels	8 Single-ended
Resolution	16-bit
Sampling Rate	200 kS/s (Each Channel)
Bipolar Input (Programmable)	+/- 10 V, +/- 5 V
FIFO Size	2 k Samples
Accuracy	0.05 % of FSR, +/- 1 LSB @ 25 °C, +/- 10 V
AD Trigger Mode (Programmable)	Software/ Analog Threshold/External Clock Trigger/Digital Trigger (Post/Pre/Delay trigger)
Digital Input	
Channels	4
Contact	Wet Contact
Sink/Source (NPN/PNP)	Sink/Source
On Voltage Level	+5 ~ +30 VDC
Off Voltage Level	1 VDC Max.
Counter	32 bits Max. Count, 1 kHz Max. Input Frequency

Digital Output	
Channels	4
Type	Isolated Open Collector
Sink/Source (NPN/PNP)	Sink
Load Voltage	+5 ~ +30 VDC
Load Current	100 mA
Short-circuit Protection	Yes
Overload Protection	1.3 A
External Clock Trigger/Digital Trigger	
Trigger Pulse Width	1.5 $\mu$ s Min.
Trigger Type	Falling Edge
On Voltage Level	+5 ~ +5.5 VDC @ 15 mA
Off Voltage Level	< 0.8 VDC
Counter	32 bits Max. Count, 30 kHz Max. Input Frequency

## Dimensions (Units: mm)

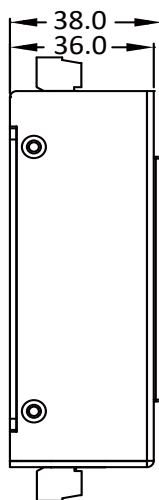

Left Side View

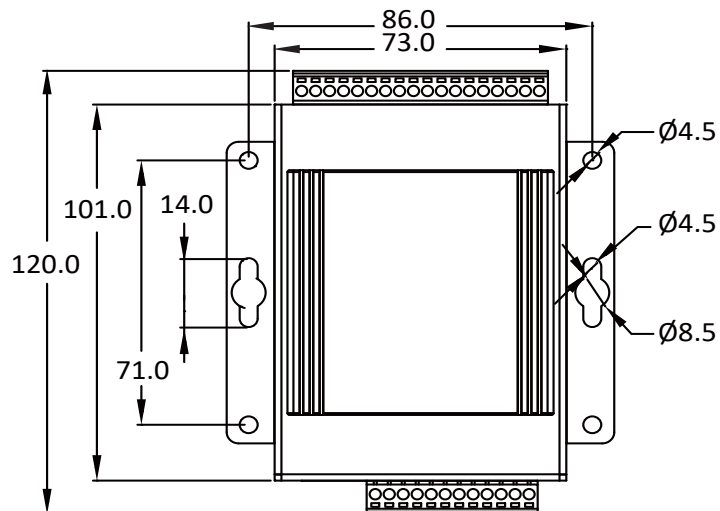

Front View

## Pin Assignments



## Wire Connections

Digital Input/Counter	ON State Readback as 1	OFF State Readback as 0
Wet Contact (Sink)		
Digital Output	ON State Readback as 1	OFF State Readback as 0
Open Collector (Sink)		
External Clock Trigger/ Digital Trigger	ON State Readback as 1	OFF State Readback as 0
Open Collector (Sink)		

Analog Input (Voltage)

## Features

### 1 Data transmission mode

#### 1. Continuous transmission (Maximum sampling rate of 30 kHz per channel)

After starting A/D acquisition, data is continuously transmitted to the Host PC.

#### 2. After collecting N data samples, the data is transferred to the Host PC (Maximum sampling rate of 200 kHz per channel)

(a) After starting A/D acquisition, the data will be temporarily stored in the memory on the PET-7H16M module, and wait until a command is received from the Host PC, before transferring the collected data to the Host PC.

(b) The memory capacity allows temporary storage of up to 30 million data samples, Storage time:

- (1) 125 seconds at a sampling rate of 30 kHz
- (2) 19.6 seconds at a sampling rate of 200 kHz

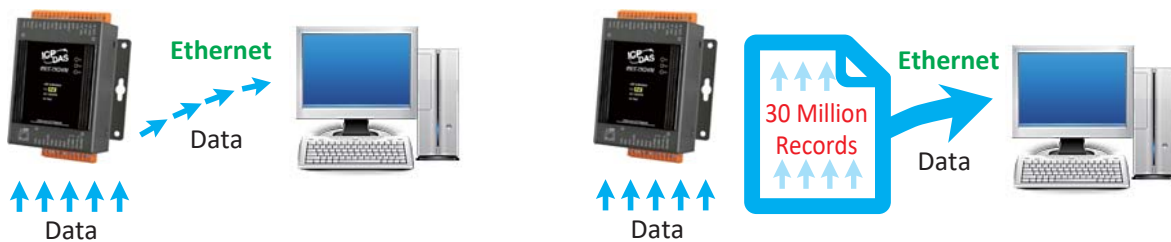

### 2 A/D trigger mode

#### 1. Software AD Data Acquisition mode

The A/D acquisition parameters are configured via a command from the Host PC. The continuous A/D acquisition or the acquisition of N data samples begins after the command is triggered.

#### 2. External Digital Signal Event Trigger mode

The A/D acquisition parameters are configured via a command from the Host PC, and then triggered via an external electrical signal. The A/D acquisition of the N data samples is then started.

### 3. Analog Threshold Trigger mode

The A/D acquisition parameters are configured via a command from the Host PC. When the analog input value is higher or lower than the set specific voltage value, the A/D acquisition of the N data is started.

### 4. External Clock Signal synchronization A/D Acquisition mode

The speed of the A/D acquisition and the amount of data acquired are controlled by external electrical signals. A falling edge for each output waveform triggers an AD conversion.

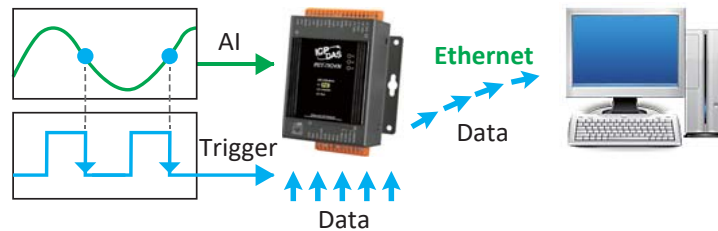

## 3 External Digital Signal Event Trigger mode

A/D acquisition is performed in external digital event trigger mode (triggering the electrical signal is the falling edge trigger). The maximum sampling rate per channel is 200 kHz, and A/D acquisition of N data samples is performed.

### 1. Pre-Trigger (acquisition of N data samples)

The A/D data is continually collected and is temporarily stored in the memory on the PET-7H16M until the trigger signal is received. Once the trigger signal is received, the collected N data samples are then transferred to the Host PC.

### 2. Post-Trigger (acquisition of N data samples)

In this mode, the A/D acquisition of the N data samples is started once the trigger signal is received.

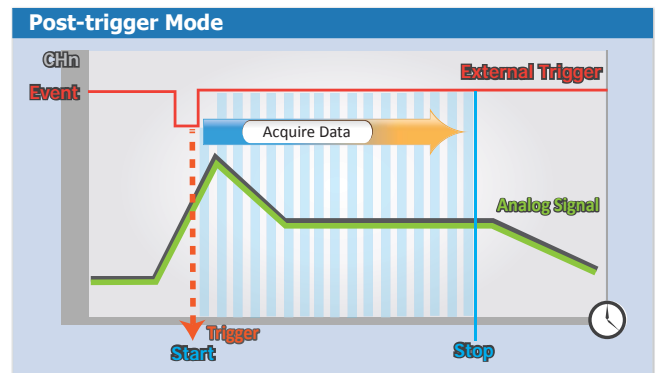
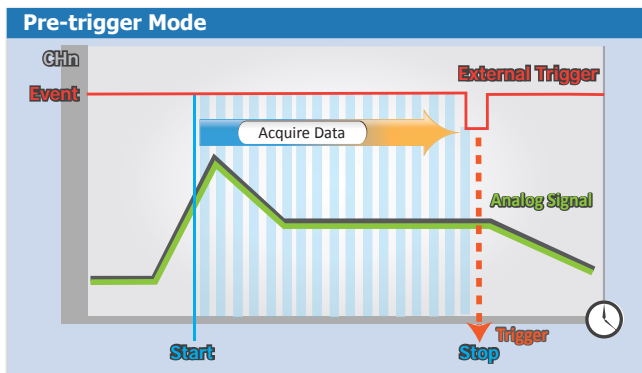

### 3. Delay-Trigger (acquisition of N data samples)

The A/D acquisition of the N data samples is started once the programmed delay period from the trigger has elapsed.

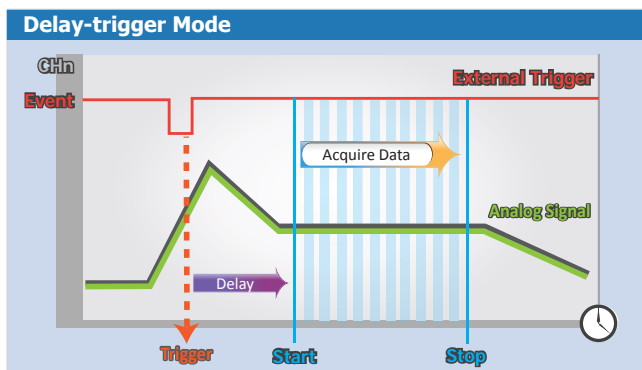

#### 4 Analog Threshold Trigger

Analog Threshold Trigger is triggered when the voltage signal of the specified analog input channel is higher or lower than a certain voltage setting. In addition, the user can also specify the trigger voltage level range of the input signal. Once the signal leaves the high and low level region or the signal enters the high and low level region, it is triggered to start the acquisition.

1. Above High: The signal is triggered above the high level and collects N data.

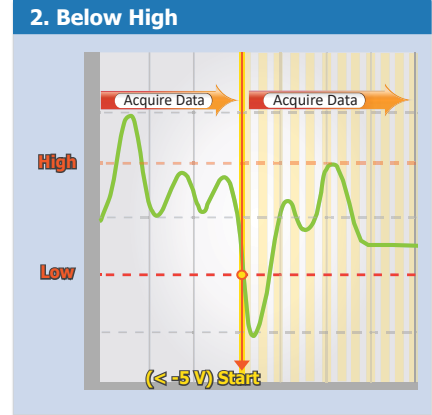
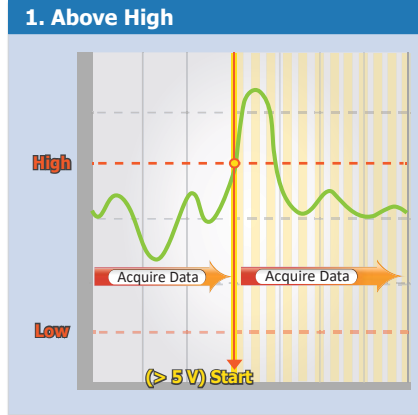

2. Below Low: The signal is triggered below the low level and collects N data.

3. Leave-region: Trigger when the signal leaves the high and low level region, collect N data.

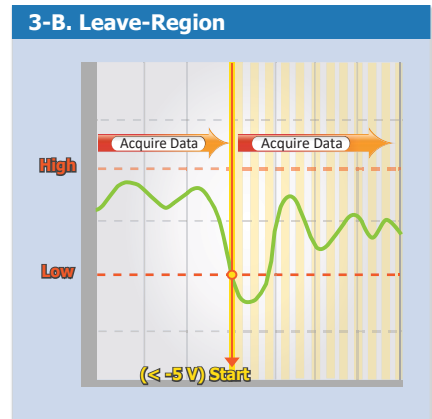
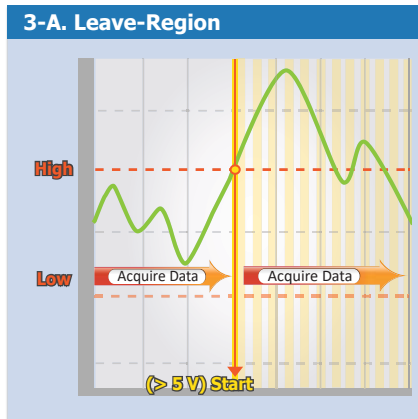

4. Entry-region: Trigger when the signal enters the high and low level region, collect N data.

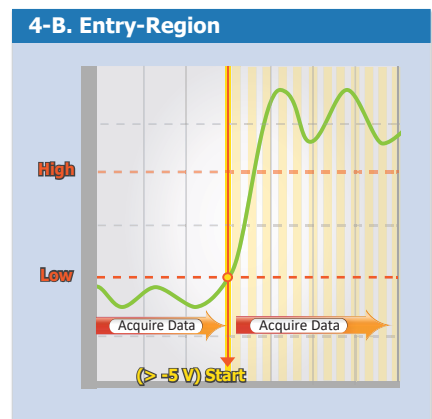
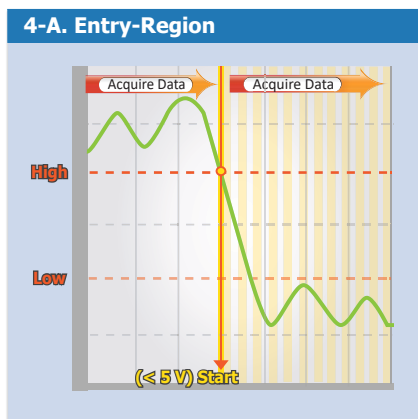

#### 5 Synchronous Counter Input

The PET-7h16M is equipped with 4-channel low-speed counters and 1-channel high-speed counter. It can be set to read the counter input synchronously with the A/D sampling time. The counter inputs can be read asynchronously by the software at any time and the counter inputs are also read synchronously with the analog input at the set sampling time. The high speed counter input is the same channel as the hardware trig+/trig- input. If the trig+/trig- input is set to the counter input. External digital signal event triggering and external clock A/D conversion data acquisition cannot be used.

## 6 A/D synchronization trigger between multiple modules

The A/D acquisition parameters are configured via a command from the Host PC, and are triggered by an external digital signal event, the A/D acquisition of N data samples, or A/D acquisition via the synchronization of an external clock signal.

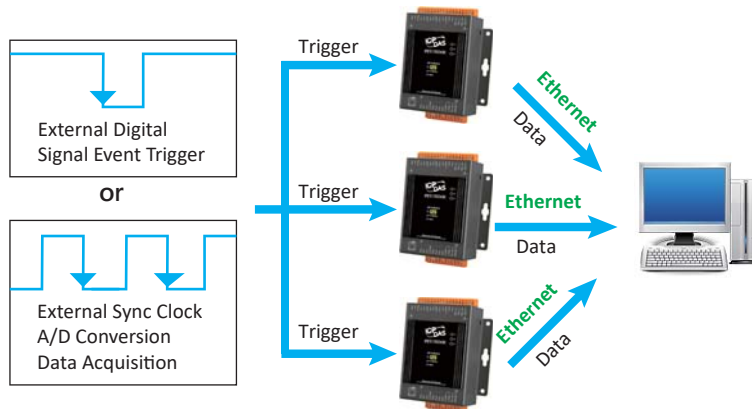

## 7 Synchronous input data acquisition with flexible data frame

The high-speed acquisition of the analog input/digital input/digital output read-back and counter input can also be read simultaneously, and these acquisition data can also be transferred to the Host PC with the Analog input sampling data. It is flexibly to define different input types into the Ethernet data frame of synchronous input data acquisition. In synchronous input data acquisition, the sampling rate can be 2 KHz Max.

The following user-defined frame consists of 8-channel AI value and 1-channel high-speed counter value.

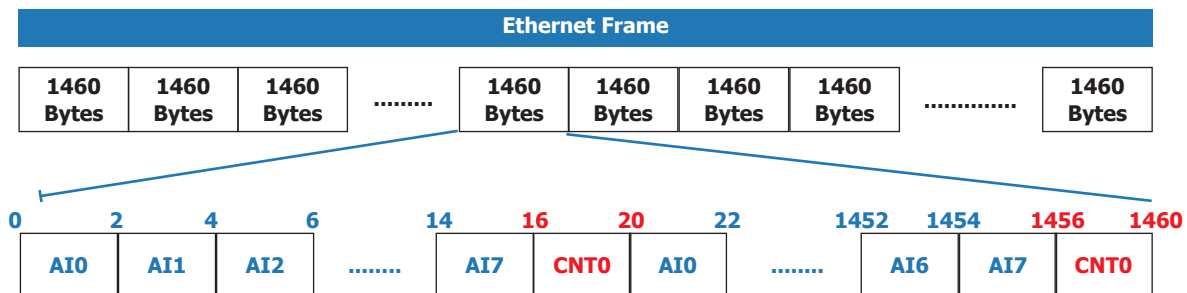

## 8 PC Software Support

1. VC, C#, VB.NET API and Demo
2. LabVIEW Toolkit and Demo

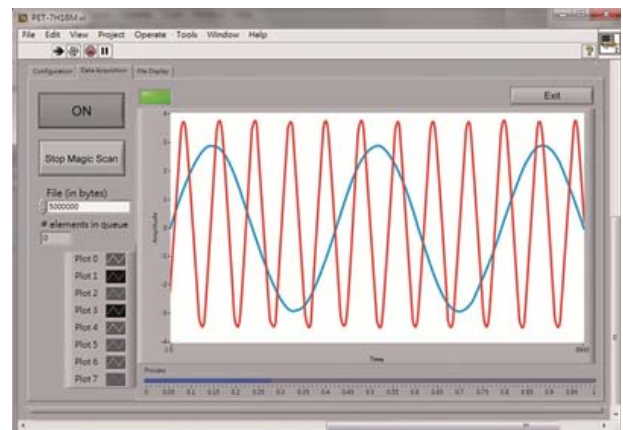
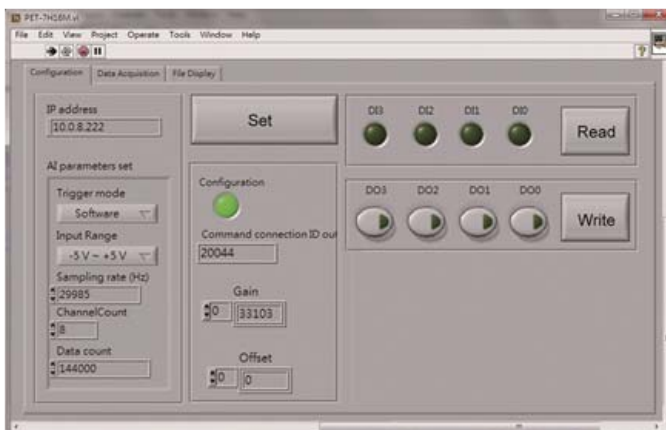

## Ordering Information

PET-7H16M	Ethernet High Speed Data Acquisition Module with 8-ch AI, 4-ch DI, 4-ch DO and PoE (RoHS)
-----------	---