



Highlight Information

- Runtime InduSoft Web Studio Inside
- PXA270 CPU (32-bit & 520 MHz)
- 128 MB SDRAM & 96 MB Flash
- IP65 Compliant Front Panel
- 3.5"/5.7" TFT LCD and Rubber Keypad
- Audio with Microphone-In and Earphone-Out
- 3 I/O Expansion Slots for VP-23W9/25W9
- One or two 10/100M Ethernet Ports
- 2 or 3 Serial Ports (RS-232, RS-485)
- DCON Bundle Driver is Provided
- Protocol Support: MODBUS, OPC DDE, SNMP...etc.
- Supports third-party SQL relational databases
- Host Application via Regular Web Browser
- Operating Temperature: -20 ~ +70 °C



Introduction

VP-23W9/25W9 and VH-23W9/25W9 are the new generation Windows CE .NET 5.0 based InduSoft PACs of ICP DAS. ViewPAC integrates WinPAC, color graphic display and keypad into one unit. It is equipped with a PXA270 CPU (520 MHz), various connectivity (USB, Ethernet, RS-232/485), 3 I/O slots, 3.5"/5.7" TFT LCD and a rubber keypad. The benefit of running Windows CE on ViewPAC includes hard real-time capability, small core size, fast boot speed, interrupt handling at a deeper level and achievable deterministic control. ViewPAC is also capable of running InduSoft and PC-based control software such as Visual Basic .NET, Visual C#, Embedded Visual C++.... etc.

InduSoft Web Studio is a powerful, integrated collection of automation tools that includes all the building blocks needed to develop modern Human Machine Interfaces (HMI), Supervisory Control and Data Acquisition (SCADA) systems, and ViewPAC applications. InduSoft Web Studio's application runs in native Windows NT, 2000, XP, CE and CE .NET environments and conforms to industry standards such as Microsoft .NET, OPC, DDE, ODBC, XML, and ActiveX.

Applications

Rich I/O Expansion Ability

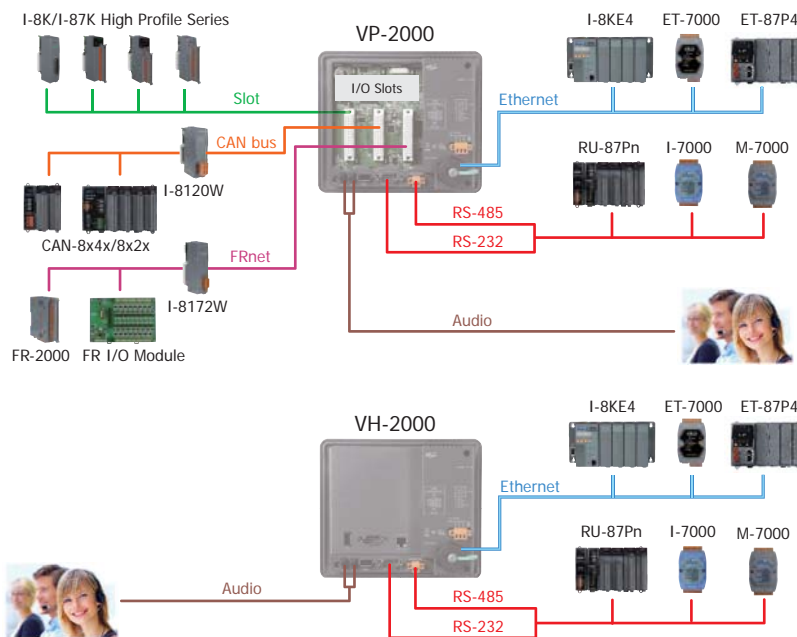

Features

Software

- Windows CE .NET 5.0 Operating System
 - FTP Server
 - VCEP Software
 - Built-in OPC Server: Quicker
 - Provides Library for eVC, C# or VB .NET
- InduSoft Web Studio v6.1 Inside
 - Simple Steps to Create sophisticated interfaces
 - Full-Featured WinCE-based run-time environment
 - DCON Bundle Driver is Provided
 - Conform to Industry Standards: Modbus, OPC, DDE, SNMP.
 - Supports third-party SQL relational databases
 - Full-Featured Web Thin Client solution
 - GSM ActiveX object is provided
 - Multi-level security for applications
- Development Software
 - InduSoft Web Studio
 - Visual Studio .NET 2003/2005/2008 and eVC

Hardware

- PXA270 CPU (32-bit & 520 MHz)
- IP65 Compliant Front Panel
- 3.5"/2.7" TFT LCD (5.7" LCD is with Touch Panel)
- Rubber Keypad with 24/6 Keys
- Audio with Microphone-In and Earphone-Out
- 3 Slots for High Profile I/O Modules (VP Series)
- 64-bit Hardware Serial Number for Software Protection
- Built-in Flash Disk (31 MB)
- Dual Battery Backup SRAM (512 KB)
- Rich I/O Expansion Ability
 - Ethernet
 - RS-232/422/485
 - FRnet
 - CAN Bus
- Operating Temperature: -20 ~ +70 °C

ViewPAC-2xW9 Total Solution

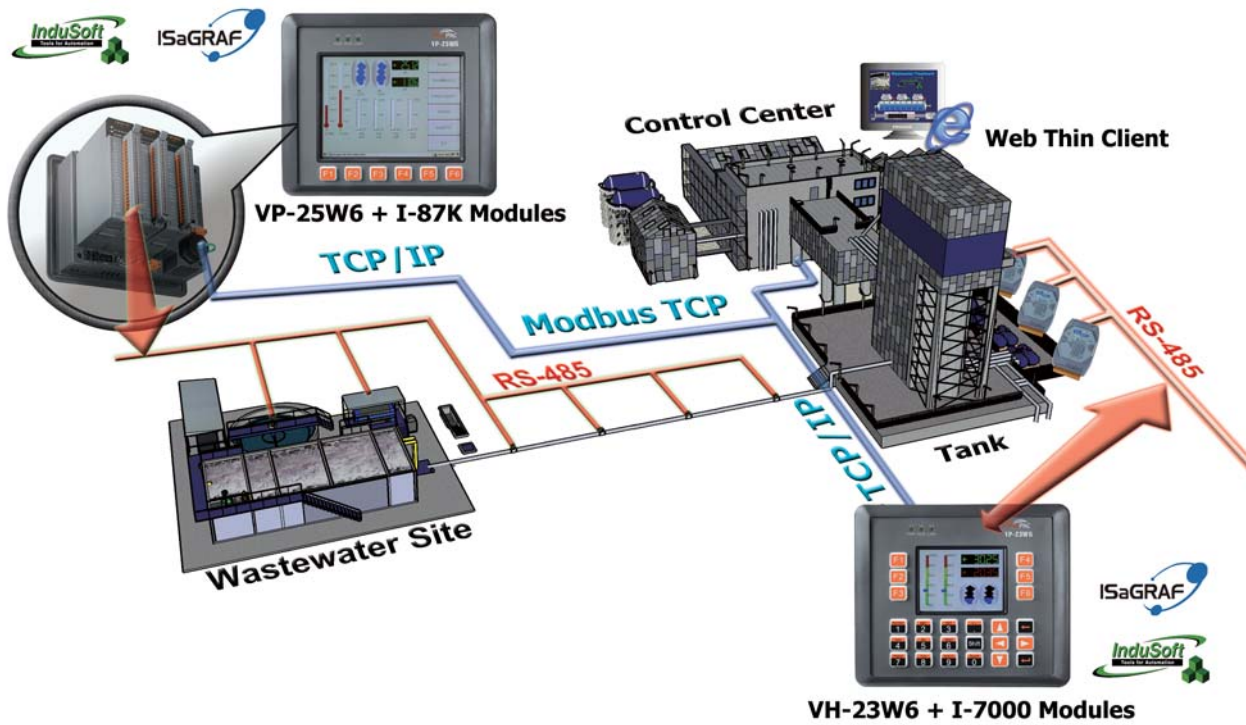

3

ViewPAC

Redundant system

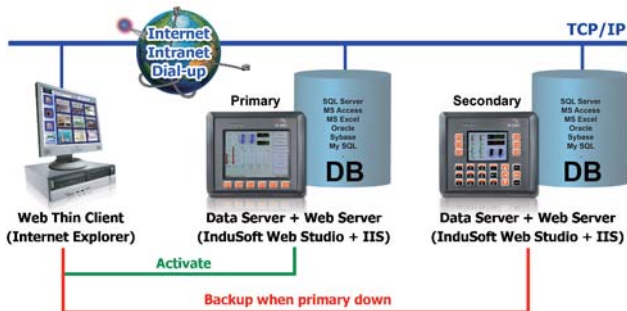

Street lamp monitor & control system

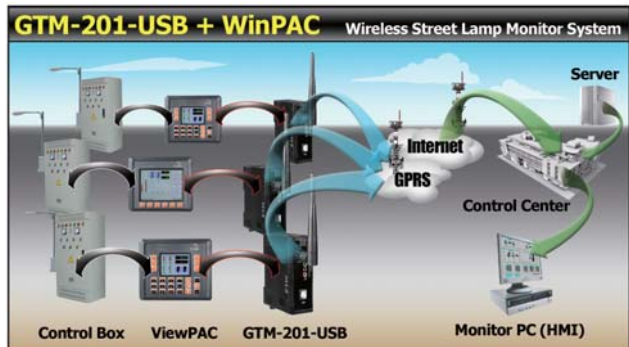

3

ViewPAC-2000 Series

Database accessible



Wastewater treatment system

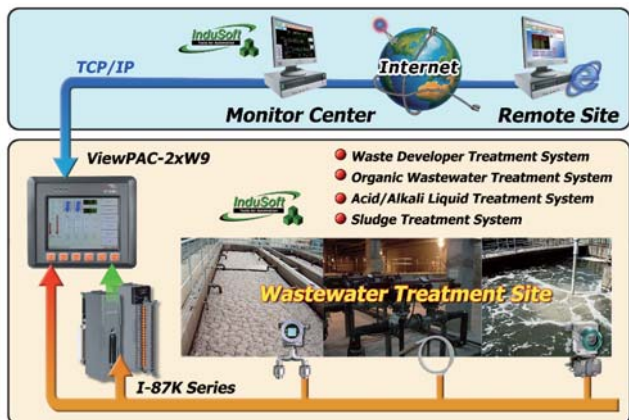

Share data with 3rd. party application

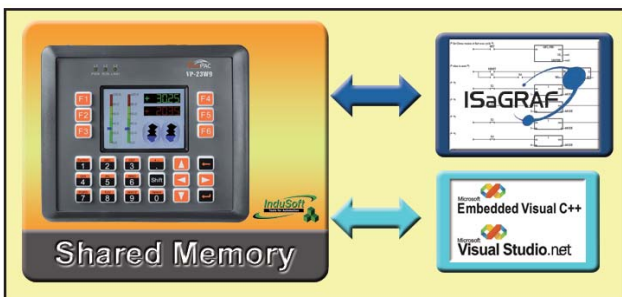

VP-23W9/VP-25W9/NH-23W9/NH-25W9

Specifications

3

ViewPAC

Models	VP-23W9	VP-25W9	VH-23W9	VH-25W9
System Software				
OS	Windows CE 5.0			
.Net Compact Framework	2.0			
Embedded Service	FTP server, Web server (supports VB script, JAVA script), Embedded SQL server			
SDK Provided	DII for eVC, DII for Visual Studio.Net 2003/2005/2008			
Development Software				
InduSoft Software	InduSoft Web Studio v6.1 Service Pack 6			
Others	Options: Microsoft EVC++ 4.0 or VS .NET 2003/2005/2008 (VB .NET 2003/2005/2008, C# .NET 2003/2005/2008)			
Web Service				
Web HMI	Support Web HMI function, PC running Internet Explorer can access to the VP-2XW9 via Local Ethernet or Internet or dial Modem, monitoring and control.			
Security	Web HMI supports three levels user name and password protection			
CPU Module				
CPU	PXA270 or compatible (32-bit and 520 MHz)		PXA270 or compatible (32-bit and 312 MHz)	
SDRAM	128 MB			
Dual Battery Backup SRAM	512 KB (for 5 years data retention)			
Flash	96 MB (64 MB for OS image, 31 MB for built-in Flash disk, 1 MB for registry)			
EEPROM	16 KB Data Retention: 40 years; 1,000,000 erase/write cycles			
Expansion Flash Memory	microSD socket with one 2 GB microSD card (support up to 16 GB microSDHC card)			
RTC (Real Time Clock)	Provide second, minute, hour, date, day of week, month, year			
64-bit Hardware Serial Number	Yes			
Dual Watchdog Timers	Yes (0.8 second)			
Rotary Switch	Yes (0 ~ 9)			
VGA & Communication Ports				
Ethernet	RJ-45 x 1, 10/100 Base-TX (Auto-negotiating, LED indicators)		RJ-45 x 2, 10/100 Base-TX (Auto-negotiating, LED indicators)	
USB 1.1 (host)	1		2	
USB 1.1 (client)	-		1	
COM 0	Internal communication with the high profile I-87K series modules in slots			
COM 1	-		RS-232 (Rx/D, Tx/D, CTS, RTS, DSR, DTR, CD, RI and GND); Non-isolated	
COM 2	RS-485	D2+, D2-; self-tuner ASIC inside		
	Isolation	2500 Vdc		
COM 3	RS-232 (Rx/D, Tx/D, CTS, RTS, DSR, DTR, CD, RI and GND); Non-isolated			
MMI (Man Machine Interface)				
LCD	3.5" TFT (Resolution 320 x 240)	5.7" TFT (Resolution 640 x 480)	3.5" TFT (Resolution 320 x 240)	5.7" TFT (Resolution 640 x 480)
Touch Panel	-	Yes	-	Yes
Rubber Keypad	24 keys	6 Keys	24 keys	6 Keys
Audio	Microphone-In and Earphone-Out			
LED Indicators	3 Dual-Color LEDs (PWR, RUN, LAN1, L1, L2, L3; L1 ~ L3 for User Programmable)			
I/O Expansion Slots				
Slot Number	3 (For High Profile I-8K and I-87K Modules Only)		-	
Hot Swap * Will be available	For High Profile I-87K Modules Only		-	
Mechanical				
Dimensions (W x H x D)	182 mm x 158 mm x 125 mm			
Installation	Panel Mounting			
Ingress Protection	Front panel: IP65			
Environmental				
Operating Temperature	-20 ~ +70 °C			
Storage Temperature	-30 ~ +80 °C			
Ambient Relative Humidity	10 ~ 90% RH (non-condensing)			
Power				
Input Range	+10 ~ +30 Vdc			
Isolation	1 kV			
Capacity	2.5 A, 5 V supply to I/O expansion slots			
Consumption	7.2 W (0.3 A @ 24 Vdc)			

3

ViewPAC-2000 Series

VP-23W9/VP-25W9/VH-23W9/VH-25W9

InduSoft Features

- Elegant Graphics
- Multi-Language
- Database (Access, Excel, SQL, Oracle...)
- Recipes and Reports
- Online and History Alarm / Event / Trend
- Various Communication Driver (DCON, Modbus, OPC, DDE, TCP/IP...)
- Remote Web Client Control & Security
- ActiveX (GSM / SHM / COM /WEB provided by ICP DAS)
- System Redundancy
- Online Configuration and debugging
- Others (VBScript, E-mail, FTP, SNMP...)

Appearance

VP-23W9/VH-23W9



VP-23W9/25W9

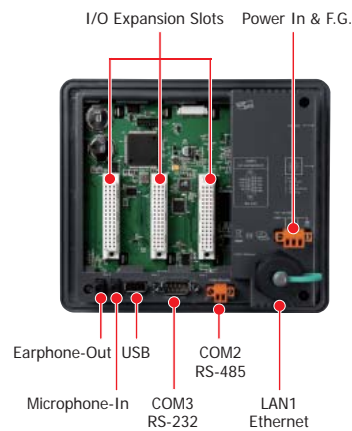

VP-25W9/VH-25W9

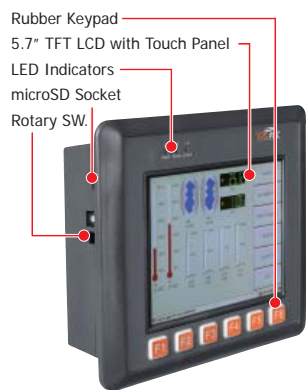

VH-23W9/25W9

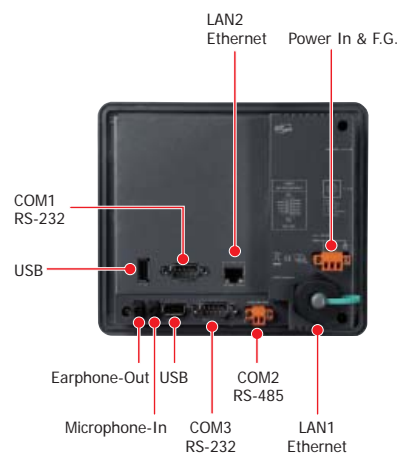

Pin Assignments

VP-23W9/25W9 COM Port

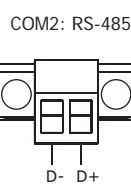
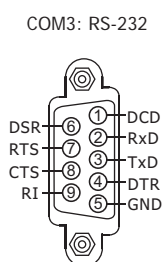

VH-23W9/25W9 COM Port

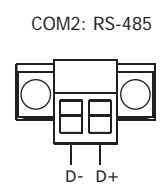
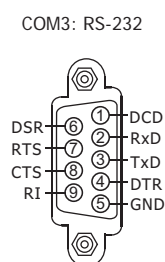
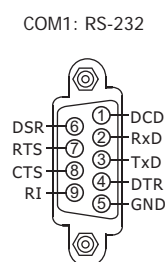

Dimensions (Unit: mm)

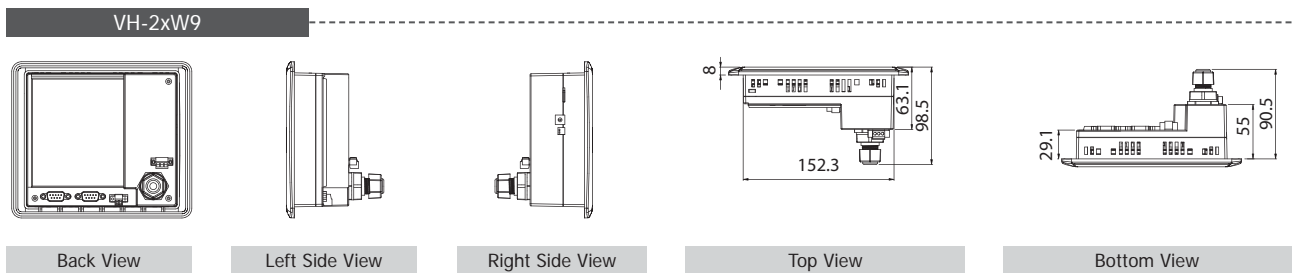
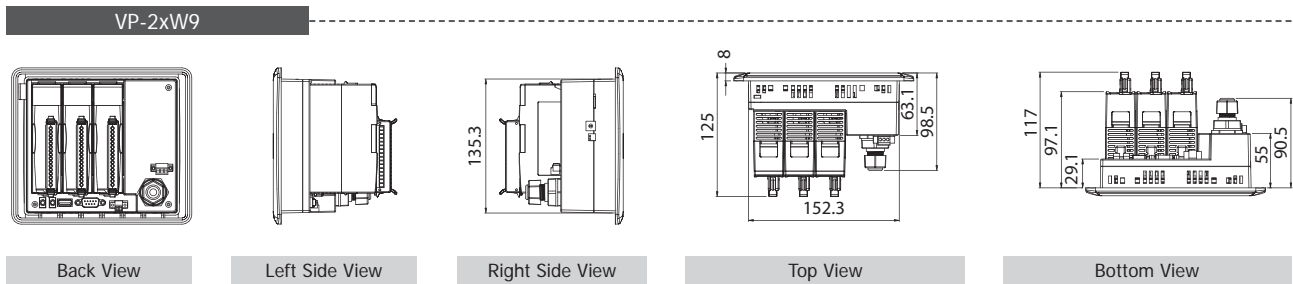
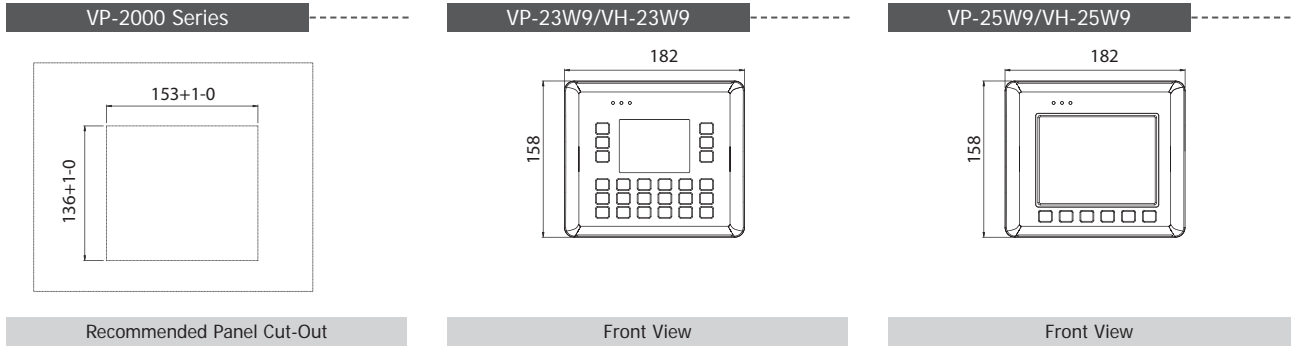

Ordering Information

VP-23W9-EN CR	InduSoft based ViewPAC with 3.5" LCD and 3 I/O slots (Multilanguage Version of OS) (RoHS)
VP-25W9-EN CR	InduSoft based ViewPAC with 5.7" LCD and 3 I/O slots (Multilanguage Version of OS) (RoHS)
VP-23W9-TC CR	InduSoft based ViewPAC with 3.5" LCD and 3 I/O slots (Traditional Chinese of OS) (RoHS)
VP-25W9-TC CR	InduSoft based ViewPAC with 5.7" LCD and 3 I/O slots (Traditional Chinese of OS) (RoHS)
VP-23W9-SC CR	InduSoft based ViewPAC with 3.5" LCD and 3 I/O slots (Simplified Chinese of OS) (RoHS)
VP-25W9-SC CR	InduSoft based ViewPAC with 5.7" LCD and 3 I/O slots (Simplified Chinese of OS) (RoHS)
Note: The default runtime license (CEView Lite Plus - 300 tags and 3 driver) is installed.	

Accessories

InduSoft Development Software	
InduSoft-NT512000D	Advanced Server for Windows NT/2000/XP (512,000 Tags, unlimited drivers)
InduSoft-NT64000D	Control Room for Windows NT/2000/XP (64,000 Tags, 8 drivers)
InduSoft-NT4000D	Operator Workstation for Windows NT/2000/XP (4,000 Tags, 5 drivers)
InduSoft-NT1500D	Local Interface for Windows NT/2000/XP (1500 Tags, 3 drivers)
InduSoft-NT300D	NTView PRO for Windows NT/2000/XP (300 Tags, 3 drivers)
InduSoft Development Software	
InduSoft-CE1500R	CEView standard for Windows CE Run-time (CE View)(1500 Tags, 3 drivers)
InduSoft-CE300R	CEView Lite Plus for Windows CE Run-time (300 Tags, 3 drivers)
Power Supply	
DP-660	24 Vdc/2.5 A, 60 W and 5 Vdc/0.5 A, 2.5 W Power Supply with DIN-Rail Mounting
MDR-20-24	24 Vdc/1.0 A, 24 W Power Supply with DIN-Rail Mounting
MDR-60-24	24 Vdc/2.5 A, 60 W Power Supply with DIN-Rail Mounting