

**I-7051(D) M-7051(D)**  
16-channel Isolated Digital Input Module

### Features

- 16-Channel Digital Input
- Dry Contact and Wet Contact Selectable via Wire Connections
- Photocouple Isolation
- Long Distance Measurement
- All Channels can be used as 16-bit Counters
- ±4 kV ESD Protection
- ±4 kV EFT Protection
- ±3 kV Surge Protection
- 3750 Vdc Isolation Voltage
- Dual Watchdog
- Wide Operating Temperature Range: -25 to +75°C



### Introduction

The I-7051 offers 16 channels for digital input, catering for both dry and wet contact, with an effective distance for dry contact of up to 500 meters. All channels not only feature Photocouple isolation, but can also be used as 16-bit counters. The I-7051D has 16 LED indicators that can be used to monitor the status of the digital input channels. 4 kV ESD protection and 3750 VDC intra-module isolation are standard. The M-7051 has the same hardware specifications as the I-7051, but provides additional support for the Modbus RTU protocol as well as the DCON protocol.

### Applications

Building Automation, Factory Automation, Machine Automation, Remote Maintenance, Remote Diagnosis, Testing Equipment.

### System Specifications

Model	I-7051	I-7051D	M-7051	M-7051D
<b>Communication</b>				
Interface	RS-485			
Bias Resistor	No (Usually supplied by the RS-485 Master. Alternatively, add a tM-SG4 or SG-785.)			
Format	(N, 8, 1) (N, 8, 2) (E, 8, 1) (O, 8, 1)			
Baud Rate	1200 to 115200 bps			
Protocol	DCON		Modbus RTU, DCON	
Dual Watchdog	Yes, Module (1.6 Seconds), Communication (Programmable)			
<b>LED Indicators/Display</b>				
System LED Indicator	Yes, 1 as Power/Communication Indicator			
I/O LED Indicators	-	Yes, 16 LEDs as Digital Input Indicators	-	Yes, 16 LEDs as Digital Input Indicators
7-segment LED Display	-			
<b>Isolation</b>				
Intra-module Isolation, Field-to-Logic	3750 Vdc			
<b>EMS Protection</b>				
ESD (IEC 61000-4-2)	±4 kV Contact for each Terminal			
	±8 kV Air for Random Point			
EFT (IEC 61000-4-4)	±4 kV for Power Line			
Surge (IEC 61000-4-5)	±3 kV for Power Line			
<b>Power</b>				
Reverse Polarity Protection	Yes			
Input Range	+10 ~ +30 Vdc			
Consumption	0.3 W	1.1 W	0.3 W	1.1 W
<b>Mechanical</b>				
Dimensions (L x W x H)	123 mm x 72 mm x 35 mm			
Installation	DIN-Rail or Wall Mounting			
<b>Environment</b>				
Operating Temperature	-25 to +75°C			
Storage Temperature	-40 to +85°C			
Humidity	10 to 95% RH, Non-condensing			

### I/O Specifications

Model	I-7051	I-7051D	M-7051	M-7051D
<b>Digital Input/Counter</b>				
Channels	16			
Type	Dry Contact	Source		
	Wet Contact	Sink/Source		
Wet Contact	ON Voltage Level	+10 ~ 50 Vdc		
	OFF Voltage Level	+4 Vdc Max.		
Dry Contact	ON Voltage Level	Close to GND		
	OFF Voltage Level	Open		
	Effective Distance for Dry Contact	500 m Max.		
Counters	Max. Count	65535 (16-bit)		
	Max. Input Frequency	100 Hz		
	Min. Pulse Width	5 ms		
Input Impedance	10 kΩ			
Channel-to-Channel Isolation	-			
Overvoltage Protection	±70 Vdc			

### Internal I/O Structure

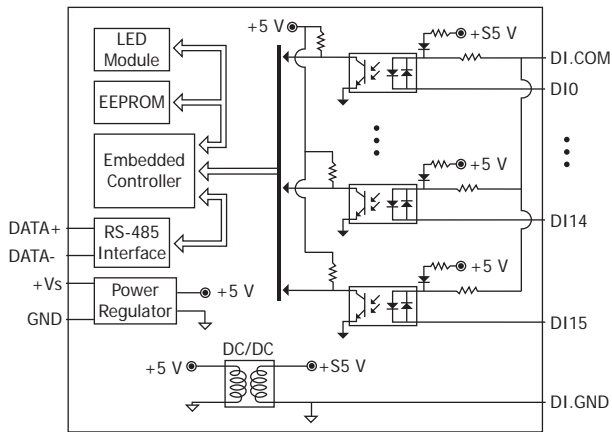

### Pin Assignments

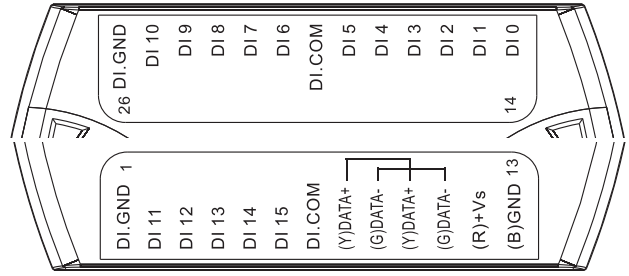



### Wire Connections



Input Type	ON State Readback as 1	OFF State Readback as 0
Dry Contact	Close to GND	Open
Wet Contact (Sink)	+10 ~ +50 VDC	+4 VDC Max.
Wet Contact (Source)	+10 ~ +50 VDC	+4 VDC Max.

### Ordering Information

I-7051 CR	16-channel Isolated Digital Input Module using the DCON Protocol (Blue Cover) (RoHS)
I-7051-G CR	16-channel Isolated Digital Input Module using the DCON Protocol (Gray Cover) (RoHS)
I-7051D CR	I-7051 with LED Display (Blue Cover) (RoHS)
I-7051D-G CR	I-7051-G with LED Display (Gray Cover) (RoHS)
M-7051-G CR	16-channel Isolated Digital Input Module using the DCON and Modbus Protocols (Gray Cover) (RoHS)
M-7051D-G CR	M-7051-G with LED Display (Gray Cover) (RoHS)

### Accessories

 tM-7520U CR	RS-232 to RS-485 Converter (RoHS)
 tM-7561 CR	USB to RS-485 Converter (RoHS)
 tM-SG4 CR	RS-485 Bias and Termination Resistor Module (RoHS)

 I-7514U CR	4-channel RS-485 Hub (RoHS)
 SG-770 CR	7-channel Differential or 14-channel Single-ended Surge Protector (RoHS)
 SG-3000 Series	Signal Conditioning Modules for Thermocouple, RTD, DC Voltage, DC Current and Power Input Transformers

2  
3

RS-485 Remote I/O Modules

I-7051/I-7051D/M-7051/M-7051D